



MOVING YOU FURTHER

25·30·32

35B-9U



Some of the photos may include optional equipment.

 **HYUNDAI**
MATERIAL HANDLING



Your satisfaction is
our priority.

Proven AC technology!
Hyundai 9 Series battery forklift

Introducing the new, upgraded Hyundai 9 Series electric pneumatic tire forklift.

The new B-9U Series brings customer added value to the next level by dramatically reducing energy costs and enhancing powertrain durability.

Work efficiency & productivity

- 32% increase in energy efficiency with EHPS (Electro Hydraulic Power Steering) system application
- Powerful and precise driving performance of dual drive motors
- Vehicle performance optimized for various working conditions
- Directional & horn switch on lever (OPT)
- 2 Door bolt on type cabin (OPT)

Durability & reliability

- Improved drive unit input shaft
- Dual micom with improved data processing reliability : ZAPI Controller
- Semi-permanent Oil Cooled Disc Brake
- IP43 Motor & IP65 Controller

Safety

- EHPS (Electro Hydraulic Power Steering)
- Automatic deceleration in travel speed when turning (Curve Control)
- Prevention of rear roll back when restarting after ramp stop (Ramp Hold)
- Maximum speed limit setting
- Operator Presence Sensing System (OPSS)

Easy management

- Self-diagnosis of electric system failure
- Durable Continental solid tire
- Brake oil level sensing system





Power&Performance

High Efficiency & Optimal Performance

An efficient, smooth running and compact design provides enhanced performance and outstanding productivity.



Some of the photos may include optional equipment.

Strong driving power : Dual drive motor system UPGRADE

The dual drive motor system consists of two separately controlled drive motors. Unlike the single drive motor system, it prevents the wheels from spinning even when the traction of the left and right wheels is different. In addition, it enables high performance in less than optimal environments such as uneven or wet pavement. As the pivot point is the axle of the wheels, the dual system enables relatively small turning radius compared to the single system, thus improving efficiency in small worksites.

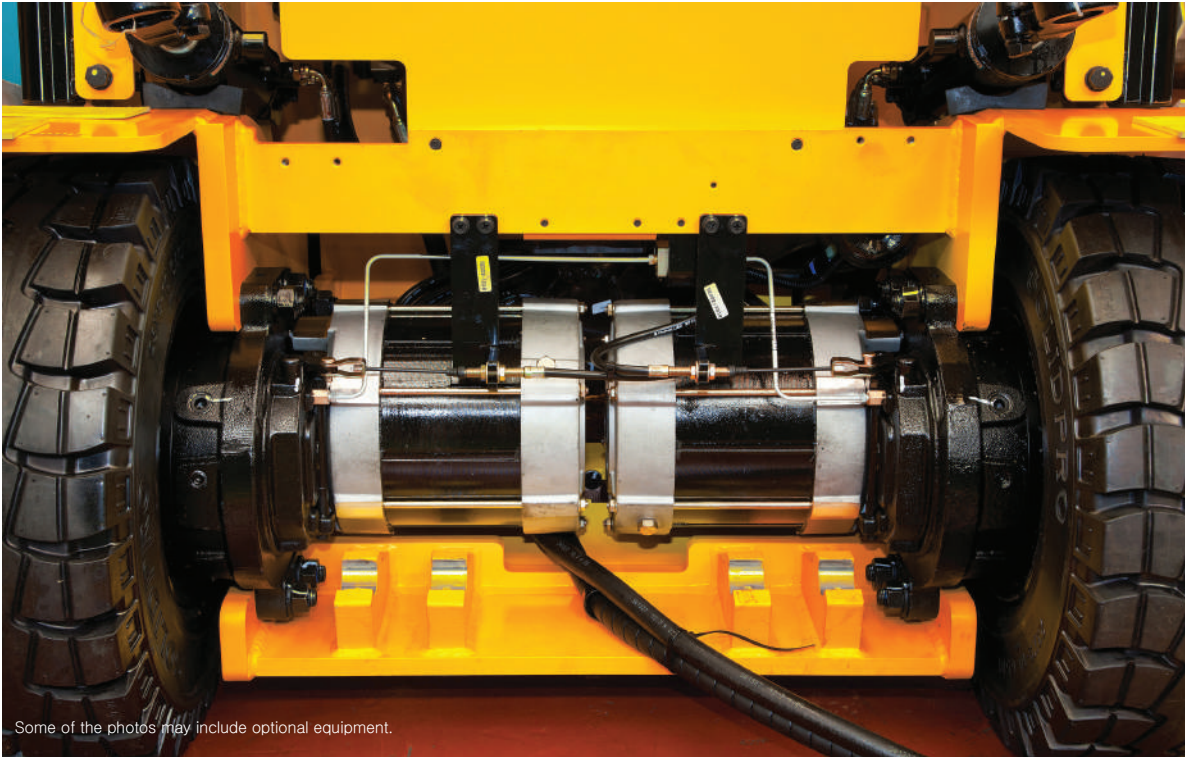

Some of the photos may include optional equipment.

Improvement in energy consumption

EHPS (Electro Hydraulic Power Steering) system only functions when the driver operates the steering wheel and significantly reduces the energy consumption because unlike the current hydraulic power steering (HPS) system, the pump doesn't continuously run in standby. Moreover, the hydraulic pump noise generated during steering standby mode of the HPS system has been completely eliminated.

Previous model (25B-9: 715Ah) : 185 minutes (100%)

Upgraded model (25B-9U : 660Ah) : 259 minutes (140%)

* The figures above are based on Hyundai's test results for a single charge cycle and may differ from actual working conditions.

UPGRADE



EHPS (Electro Hydraulic Power Steering)

With the energy efficiency of electric power steering and the stability of the hydraulic power steering, the EHPS system is composed of a torque sensor, controller, motor, hydraulic pump, and steering cylinder, and efficiently operates with little energy required.

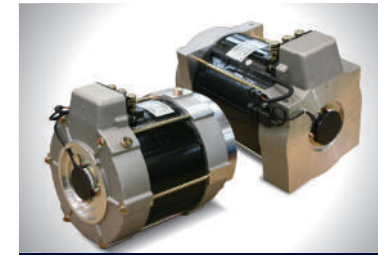

Robust and economical AC motor

The enclosed drive and pump motors with AC technology combine power, extended maintenance intervals and excellent durability. The brushless AC motors offer improved efficiency and reduced maintenance cost. It is certified IP43.

UPGRADE



Dual MiCOM ZAPI controller

The new ZAPI AC controller with dual micom and made by ZAPI monitors the dual signals and detects faults. So it is possible to control the forklift quickly and securely.



Wet disc brake

The wet disc brake system is virtually maintenance free and the enclosed design protects from dust and water.

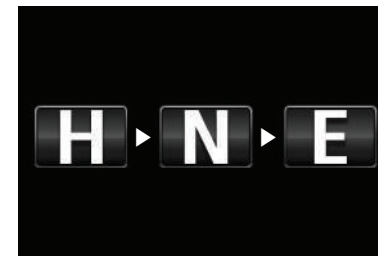

Optimized operation mode setting

Through the cluster and ZAPI controller function, optimal performance mode - H (High), N (Normal), E (Economic) - can be selected based on working conditions, worksite size and operator's proficiency.

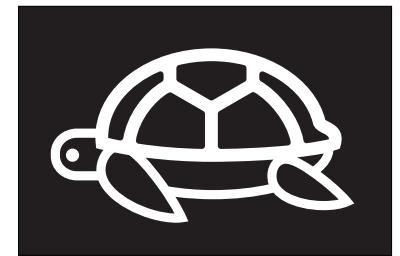

Turtle mode

Selecting turtle mode allows the operator to reduce travel to a pre-set speed, which is ideal when working in narrow and or congested work areas.



Easy & Comfort

Optimized Ergonomics & Fast and Easy Maintenance

An ideal arrangement of components ensures easy access and convenience for maintenance.



COMFORTABLE WORKSPACE

ADVANCED MONITORING SYSTEM

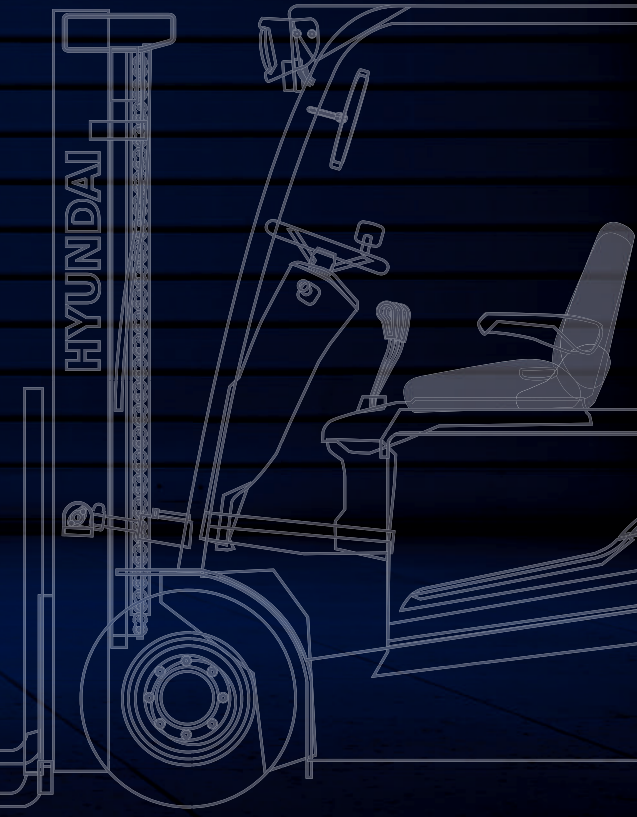

Some of the photos may include optional equipment.

Ergonomically designed workspace

Ergonomic design focusing on operator convenience and maneuverability further enhances work efficiency. Easy to operate levers and pedals, adjustable handle, suspension seat and a large multi-functional cluster dashboard allow comfortable and efficient driving. A 12V power socket is an optional feature to improve operator convenience.



Some of the photos may include optional equipment.



Grammer seat

Adjustable ergonomic seat provides unmatched comfort. The adjustable armrest further reduces operator fatigue.

- Accommodates operator weights from 50 to 160 kg.(110 to 353 lbs).
- ELR (Emergency Locking Retractable) type seat belt
- Heater and headrest (OPT)



Steering wheel position

A steer sensor is installed on the king pin of the rear axle, communicating on the LCD display to show the direction of the vehicle in relation to the steer wheel angle.



Directional & horn switch on lever (OPT)

An optional electronic directional control and secondary horn are mounted to the hydraulic lift lever for quick and precise directional control. Also, the position of the horn button provide quick access if needed.



Adjustable steering wheel

The angle of the steering column can easily be adjusted to improve operator comfort.

4.3inch LCD color monitor

The LCD color monitor with 4.3 inch graphic smart display allows the operator to identify speed, travel direction, and operating hours and control the machine efficiently. The load indicator displays the load weight in the monitor. The operator can select various performance modes to meet all working conditions. Multilanguage (maximum 12) is available.

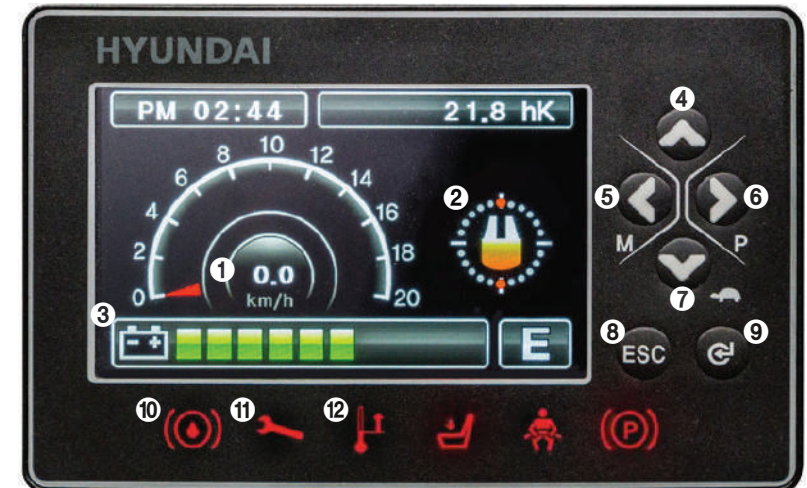

Main functions

- | | |
|--|------------------------------|
| ① Speed (Digital) | ⑦ Turtle / Scroll down |
| ② Steering wheel position and travel direction | ⑧ ESC / Back |
| ③ Battery discharge indicator | ⑨ Enter |
| ④ Scroll up | ⑩ Low brake oil warning lamp |
| ⑤ Menu / Scroll Left | ⑪ Error warning lamp |
| ⑥ Performance / Scroll right | ⑫ High temp warning lamp |



Easy maintenance of battery

The battery cover opens fully with the assistance of a gas strut that locks when fully opened to give easy access to battery and prevent the hood from dropping.



Brake oil reservoir with level sensor

The enhanced brake oil reservoir, located in the upper left dash is equipped with an electronic level sensor that shows the level in the LCD color monitor.



Secure & Safety

Advanced Safety

The safely designed driver's space makes your operator more comfortable.

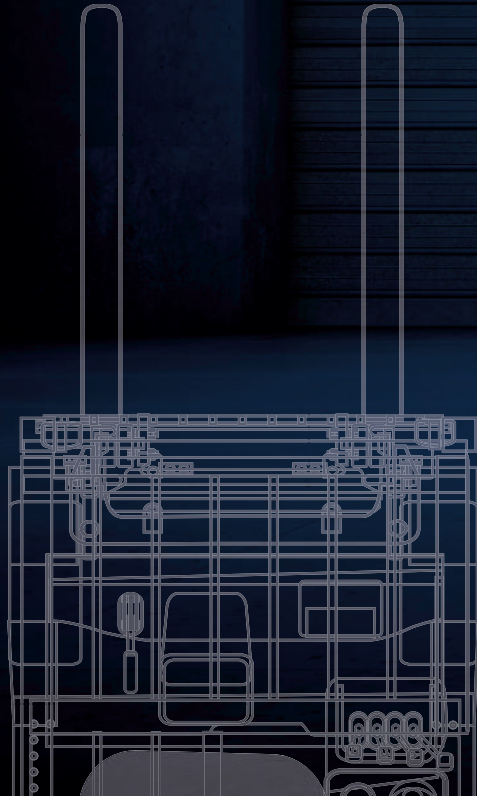

EXCELLENT VISIBILITY

ADVANCED SAFETY



Some of the photos may include optional equipment.



You can see the video by scanning the QR code.

Excellent visibility for safe operation

Lift cylinders and lifting chains are positioned behind the mast rails for optimum visibility. A rear camera(OPT) and panoramic mirror expands the driver's view when backing up.



Some of the photos may include optional equipment.



Strong overhead guard

Exceeding ISO 6055 regulations, the overhead guard offers great protection combined with excellent all around visibility.



Curve control

Curve Control limits travel speed based on turning radius, reducing speed for a smooth, precise turning operation for the driver.

Maximum speed control

The operator can set and limit the maximum speed from 11 mph to 0.5 mph unit, given the curve & congestion of an aisle and the shape of the load.

Password starting system

By granting the operation authority only to the designated driver, it is possible to manage the vehicle and prevent theft.

Safety features

The adoption of a high-sensitivity sensor and advanced safety system can prevent accidents.

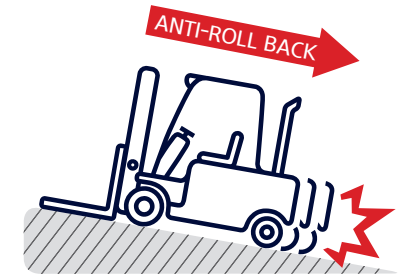

Anti roll back system

Anti Roll-back system offers protection against the machine rolling back on a ramp in combination with exceptional ramp start capabilities.

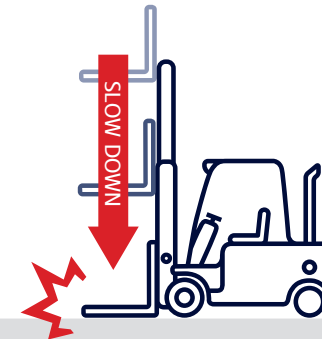

Fork safety features

As the forks are being lowered, a down-control valve maintains a controlled descent speed. The down-safety valve prevents forks from dropping down in case of sudden damage of hydraulic line.



Operator Presence Sensing System(OPSS)

When operator is not in seat the hydraulic lift and tilt controls and travel are locked out.



Strengthened work safety

Rear LED lights offer excellent visibility even during night operations. Safety has been increased by installing additional reflectors on the counterweight.

New 9 Series Mast Specification

25/30/32/35B-9U

25B-9U



Mast Type		Maximum Fork Height		Overall Height (Lowered)		Free lift height						Tilt Angle		Load capacity w/o side shift		Load capacity w/side shift		TRUCK WEIGHT (UNLOADED)	
		in	mm	in	mm	With Load Backrest		Without Load Backrest		Without Load Backrest		Fwd deg	Bwd deg	24 in LC lb	500mm LC kg	24 in LC lb	500mm LC kg	lb	kg
						in	mm	in	mm	in	mm								
2-STAGE LIMITED FREE LIFT	V300	118.3	3005	79.2	2012	4.5	115	4.5	115	4.5	115	6	10	5000	2500	5000	2500	9615	4362
	※V330	130.1	3305	85.1	2162	4.5	115	4.5	115	4.5	115	6	10	5000	2500	5000	2500	9615	4362
	V350	138.0	3505	89.1	2262	4.5	115	4.5	115	4.5	115	6	10	5000	2500	5000	2500	9615	4362
	V370	145.9	3705	95.0	2412	4.5	115	4.5	115	4.5	115	6	10	5000	2500	5000	2475	9615	4362
	V400	157.7	4005	100.9	2562	4.5	115	4.5	115	4.5	115	6	10	5000	2500	5000	2425	9615	4362
	V430	169.5	4305	106.8	2712	4.5	115	4.5	115	4.5	115	6	6	5000	2450	5000	2375	9615	4362
	V450	177.4	4505	112.7	2862	4.5	115	4.5	115	4.5	115	6	6	4960	2400	4740	2325	9615	4362
	V470	185.2	4705	116.6	2962	4.5	115	4.5	115	4.5	115	6	6	4890	2360	4670	2285	9615	4362
	V500	197.0	5005	122.5	3112	4.5	115	4.5	115	4.5	115	6	6	4810	2350	4590	2275	9615	4362
2-STAGE FULL FREE LIFT	VF/VS295	117.2	2976	79.2	2012	32.8	832	54.3	1379	54.3	1379	6	6	5000	2500	5000	2500	9615	4362
	VF/VS325	129.0	3276	85.1	2162	38.7	982	60.2	1529	60.2	1529	6	6	5000	2500	5000	2500	9615	4362
	VF/VS345	136.9	3476	89.1	2262	42.6	1082	64.1	1629	64.1	1629	6	6	5000	2500	5000	2475	9615	4362
3-STAGE FULL	TF/TS370	145.9	3705	71.3	1812	24.9	632	46.4	1179	46.4	1179	6	6	5000	2500	5000	2475	9615	4362
	TF/TS400	157.7	4005	75.3	1912	28.8	732	50.4	1279	50.4	1279	6	6	5000	2500	4870	2425	9615	4362
	TF/TS430	169.5	4305	79.2	2012	32.8	832	54.3	1379	54.3	1379	6	6	4960	2450	4740	2375	9615	4362
	TF/TS450	177.4	4505	83.1	2112	36.7	932	58.2	1479	58.2	1479	6	6	4890	2400	4670	2325	9615	4362
	TF/TS470	185.2	4705	85.1	2162	38.7	982	60.2	1529	60.2	1529	6	6	4830	2350	4610	2275	9615	4362
	TF/TS500	197.0	5005	89.1	2262	42.6	1082	64.1	1629	64.1	1629	6	6	4140	1880	4080	1850	9615	4362
	TF/TS550	216.7	5505	96.9	2462	50.5	1282	72.0	1829	72.0	1829	6	6	3410	1550	3150	1430	9615	4362
	TF/TS600	236.4	6005	104.8	2662	58.3	1482	79.9	2029	79.9	2029	6	6	3080	1400	2800	1280	9615	4362
	TF/TS650	256.1	6505	112.7	2862	66.2	1682	81.1	2061	85.5	1921	3	3	2980	1350	2700	1230	9615	4362
TF/TS700	275.8	7005	120.6	3062	74.1	1882	89.0	2261	93.4	2121	3	3	2530	1150	2050	930	9615	4362	
4-STAGE FULL FREE LIFT	QF610	240.7	6115	84.5	2147	38.1	967	55.6	1413	59.6	1462	3	3	3530	1600	3260	1480	9615	4362
	QF660	260.4	6615	92.4	2347	45.9	1167	63.5	1613	67.5	1662	3	3	3080	1400	2820	1280	9615	4362
	QF700	276.2	7015	96.3	2447	49.9	1267	67.4	1713	71.4	1762	3	3	2420	1100	2160	980	9615	4362
	QF745	293.9	7465	102.2	2597	55.8	1417	77.3	1964	77.3	1762	3	3	1760	800	1500	680	9615	4362
	QF790	311.6	7915	108.1	2747	61.7	1567	83.2	2114	83.2	1762	3	3	1320	600	1050	480	9615	4362

※ TF-Mast : Wide Visible 3-Stage Full Free Lift Mast with 1 Free Lift Cylinder
 ※ TS-Mast : Wide Visible 3-Stage Full Free Lift Mast with 2 Free Lift Cylinders

※ : Standard

New 9 Series Mast Specification

25/30/32/35B-9U

30B-9U



Mast Type	Maximum Fork Height		Overall Height (Lowered)		Free lift height						Tilt Angle		Load capacity w/o side shift		Load capacity w/side shift		TRUCK WEIGHT (UNLOADED)		
					With Load Backrest		Without Load Backrest		Without Load Backrest (3/4-SPOOL)		Fwd	Bwd	24 in LC	500mm LC	24 in LC	500mm LC			
	in	mm	in	mm	in	mm	in	mm	in	mm	deg	deg	lb	kg	lb	kg	lb	kg	
2-STAGE LIMITED FREE LIFT	V300	118.3	3005	79.2	2012	4.5	115	4.5	115	4.5	115	6	10	6000	3000	6000	3000	10171	4614
	※V330	130.1	3305	85.1	2162	4.5	115	4.5	115	4.5	115	6	10	6000	3000	6000	3000	10214	4633
	V350	138.0	3505	89.1	2262	4.5	115	4.5	115	4.5	115	6	10	6000	3000	6000	3000	10214	4633
	V370	145.9	3705	95.0	2412	4.5	115	4.5	115	4.5	115	6	10	6000	3000	6000	3000	10214	4633
	V400	157.7	4005	100.9	2562	4.5	115	4.5	115	4.5	115	6	10	6000	3000	6000	3000	10214	4633
	V430	169.5	4305	106.8	2712	4.5	115	4.5	115	4.5	115	6	6	6000	3000	6000	3000	10214	4633
	V450	177.4	4505	112.7	2862	4.5	115	4.5	115	4.5	115	6	6	6000	3000	6000	2950	10214	4633
	V470	185.2	4705	116.6	2962	4.5	115	4.5	115	4.5	115	6	6	6000	3000	6000	2875	10214	4633
2-STAGE FULL FREE LIFT	V500	197.0	5005	122.5	3112	4.5	115	4.5	115	4.5	115	6	6	6000	2900	6000	2775	10214	4633
	VF/VS295	117.2	2976	79.2	2012	32.8	832	54.3	1379	54.3	1379	6	6	6000	3000	6000	3000	10214	4633
	VF/VS325	129.0	3276	85.1	2162	38.7	982	60.2	1529	60.2	1529	6	6	6000	3000	6000	2950	10214	4633
3-STAGE FULL FREE LIFT	VF/VS345	136.9	3476	89.1	2262	42.6	1082	61.7	1567	61.7	1567	6	6	6000	3000	6000	2875	10214	4633
	TF/TS370	145.9	3705	71.3	1812	24.9	632	44.0	1117	42.6	1081	6	6	6000	3000	6000	3000	10214	4633
	TF/TS400	157.7	4005	75.3	1912	28.8	732	47.9	1217	46.5	1181	6	6	6000	3000	6000	3000	10214	4633
	TF/TS430	169.5	4305	79.2	2012	32.8	832	51.9	1317	50.4	1281	6	6	6000	3000	6000	2950	10214	4633
	TF/TS450	177.4	4505	83.1	2112	36.7	932	55.8	1417	55.8	1417	6	6	6000	3000	6000	2875	10214	4633
	TF/TS470	185.2	4705	85.1	2162	38.7	982	57.8	1467	56.3	1431	6	6	6000	2950	6000	2825	10214	4633
	TF/TS500	197.0	5005	89.1	2262	42.6	1082	61.7	1567	60.3	1531	6	6	4950	2250	4800	2180	10214	4633
	TF/TS550	216.7	5505	96.9	2462	50.5	1282	69.6	1767	69.6	1767	6	6	3850	1750	3450	1570	10214	4633
	TF/TS600	236.4	6005	104.8	2662	58.3	1482	77.4	1967	77.4	1967	6	6	3200	1450	2800	1270	10214	4633
	TF/TS650	256.1	6505	112.7	2862	66.2	1682	81.1	2061	75.6	1921	3	3	3080	1400	2690	1220	10214	4633
4-STAGE FULL FREE LIFT	TF/TS700	275.8	7005	120.6	3062	74.1	1882	89.0	2261	83.5	2121	3	3	2650	1200	2250	1020	10214	4633
	QF610	240.7	6115	84.5	2147	38.1	967	59.6	1514	59.6	1514	3	3	3750	1700	3350	1520	10214	4633
	QF660	260.4	6615	92.4	2347	45.9	1167	67.5	1714	67.5	1714	3	3	3300	1500	2900	1320	10214	4633
	QF700	276.2	7015	96.3	2447	49.9	1267	71.4	1814	71.4	1814	3	3	2650	1200	2250	1020	10214	4633
	QF745	293.9	7465	102.2	2597	55.8	1417	77.3	1964	72.2	1834	3	3	1980	900	1580	720	10214	4633
QF790	311.6	7915	108.1	2747	61.7	1567	78.2	1987	72.2	1834	3	3	1540	700	1150	520	10214	4633	

※ TF-Mast : Wide Visible 3-Stage Full Free Lift Mast with 1 Free Lift Cylinder

※ : Standard

※ TS-Mast : Wide Visible 3-Stage Full Free Lift Mast with 2 Free Lift Cylinders

New 9 Series Mast Specification

25/30/32/35B-9U

32B-9U



Mast Type		Maximum Fork Height		Overall Height (Lowered)		Free Lift Height						Tilt Angle		Load capacity w/o side shift		Load capacity w/side shift		TRUCK WEIGHT (UNLOAD)	
						with bkr		w/o bkr		w/o bkr (3/4-SPOOL)		Fwd	Bwd	24 in LC	500mm LC	24 in LC	500mm LC	lb	kg
		in	mm	in	mm	in	mm	in	mm	in	mm	deg	deg	lb	kg	lb	kg	lb	kg
2-STAGE LIMITED FREE LIFT	V300	118.3	3005	82.0	2082	4.5	115	4.5	115	4.5	115	6	10	6500	3200	6500	3200	10626	4820
	※V330	130.1	3305	87.9	2232	4.5	115	4.5	115	4.5	115	6	10	6500	3200	6500	3200	10626	4820
	V350	138.0	3505	91.8	2332	4.5	115	4.5	115	4.5	115	6	10	6500	3200	6500	3075	10626	4820
	V370	145.9	3705	97.7	2482	4.5	115	4.5	115	4.5	115	6	10	6500	3190	6500	3065	10626	4820
	V400	157.7	4005	103.6	2632	4.5	115	4.5	115	4.5	115	6	10	6500	3120	6500	2995	10626	4820
	V430	169.5	4305	109.5	2782	4.5	115	4.5	115	4.5	115	6	6	6500	3050	6450	2925	10626	4820
	V450	177.4	4505	115.4	2932	4.5	115	4.5	115	4.5	115	6	6	6500	3000	6340	2875	10626	4820
	V470	185.2	4705	119.4	3032	4.5	115	4.5	115	4.5	115	6	6	6500	2960	6250	2835	10626	4820
V500	197.0	5005	125.3	3182	4.5	115	4.5	115	4.5	115	6	6	6390	2900	6090	2775	10626	4820	
2-STAGE FULL FREE LIFT	VF/VS295	117.2	2976	82.0	2082	35.9	913	54.2	1377	54.2	1377	6	6	6500	3200	6500	3200	10626	4820
	VF/VS325	129.0	3276	88.3	2232	41.9	1063	60.1	1527	60.1	1527	6	6	6500	3200	6500	3200	10626	4820
	VF/VS345	136.9	3476	91.8	2332	45.8	1163	64.1	1627	64.1	1627	6	6	6500	3200	6500	3075	10626	4820
3-STAGE FULL FREE LIFT	TF370/TS370	145.9	3705	74.1	1882	27.6	702	43.8	1112	43.8	1112	6	6	6500	3190	6500	3065	10626	4820
	TF400/TS400	157.7	4005	78.0	1982	31.6	802	47.7	1212	47.7	1212	6	6	6500	3120	6500	2995	10626	4820
	TF430/TS430	169.5	4305	82.0	2082	35.5	902	51.7	1312	51.7	1312	6	6	6500	3060	6470	2935	10626	4820
	TF450/TS450	177.4	4505	85.9	2182	39.4	1002	55.6	1412	55.6	1412	6	6	6500	3010	6360	2885	10626	4820
	TF470/TS470	185.2	4705	87.9	2232	41.4	1052	57.6	1462	57.6	1462	6	6	6460	2980	6160	2855	10626	4820
	TF500/TS500	197.0	5005	91.8	2332	45.4	1152	61.5	1562	61.5	1562	6	6	5500	2500	6050	2795	10626	4820
	TF550/TS550	216.7	5505	99.7	2532	53.2	1352	69.4	1762	69.4	1762	6	6	4850	2200	5850	2695	10626	4820
	TF600/TS600	236.4	6005	107.6	2732	61.1	1552	77.2	1962	77.2	1962	6	6	3300	1500	5650	2605	10626	4820
	TF650/TS650	256.1	6505	115.4	2932	69.0	1752	85.1	2162	81.1	2061	3	3	3200	1450	4440	2175	10626	4820
TF700/TS700	275.8	7005	123.3	3132	76.9	1952	93.0	2362	89.0	2261	3	3	2750	1250	3650	1775	10626	4820	
4-STAGE FULL FREE LIFT	QF610	240.7	6115	84.1	2136	38.1	967	59.6	1514	59.6	1514	3	3	3950	1800	3450	1685	10626	4820
	QF660	260.4	6615	92.0	2336	45.9	1167	67.5	1714	67.5	1714	3	3	3500	1600	3250	1585	10626	4820
	QF700	276.2	7015	95.9	2436	49.9	1267	71.4	1814	71.4	1814	3	3	2850	1300	2680	1295	10626	4820
	QF745	293.9	7465	101.8	2586	55.8	1417	77.3	1964	75.5	1917	3	3	2200	1000	1570	765	10626	4820
	QF790	311.6	7915	107.7	2736	61.7	1567	81.5	2070	75.5	1917	3	3	1750	800	760	375	10626	4820

※ TF-Mast : Wide Visible 3-Stage Full Free Lift Mast with 1 Free Lift Cylinder
 ※ TS-Mast : Wide Visible 3-Stage Full Free Lift Mast with 2 Free Lift Cylinders

※ : Standard

New 9 Series Mast Specification

25/30/32/35B-9U

35B-9U



Mast Type		Maximum Fork Height		Overall Height (Lowered)		Free Lift Height						Tilt Angle		Load capacity w/o side shift		Load capacity w/side shift		TRUCK WEIGHT (UNLOAD)	
						with bkr		w/o bkr		w/o bkr (3/4-		Fwd	Bwd	24 in LC	500mm LC	24 in LC	500mm LC	lb	kg
		in	mm	in	mm	in	mm	in	mm	in	mm	deg	deg	lb	kg	lb	kg	lb	kg
2-STAGE LIMITED FREE LIFT	V300	118.3	3005	82.4	2093	4.5	115	4.5	115	4.5	115	6	10	7000	3500	7000	3500	11067	5020
	※V330	130.1	3305	88.3	2243	4.5	115	4.5	115	4.5	115	6	10	7000	3500	7000	3500	11067	5020
	V350	138.0	3505	92.2	2343	4.5	115	4.5	115	4.5	115	6	10	7000	3500	7000	3500	11067	5020
	V370	145.9	3705	98.1	2493	4.5	115	4.5	115	4.5	115	6	10	7000	3500	7000	3500	11067	5020
	V400	157.7	4005	104.1	2643	4.5	115	4.5	115	4.5	115	6	10	7000	3500	7000	3430	11067	5020
	V430	169.5	4305	110.0	2793	4.5	115	4.5	115	4.5	115	6	6	7000	3500	7000	3350	11067	5020
	V450	177.4	4505	115.9	2943	4.5	115	4.5	115	4.5	115	6	6	7000	3450	7000	3300	11067	5020
	V470	185.2	4705	119.8	3043	4.5	115	4.5	115	4.5	115	6	6	7000	3400	6810	3250	11067	5020
2-STAGE FULL FREE LIFT	V500	197.0	5005	125.7	3193	4.5	115	4.5	115	4.5	115	6	6	6920	3300	6620	3150	11067	5020
	VF/VS295	117.2	2976	82.4	2093	35.9	913	54.2	1377	54.2	1377	6	6	7000	3500	7000	3500	11067	5020
	VF/VS325	129.0	3276	88.3	2243	41.9	1063	60.1	1527	60.1	1527	6	6	7000	3500	7000	3430	11067	5020
3-STAGE FULL FREE LIFT	VF/VS345	136.9	3476	92.2	2343	45.8	1163	64.1	1627	64.1	1627	6	6	7000	3500	7000	3350	11067	5020
	TF/TS370	145.9	3705	74.5	1893	28.1	713	46.3	1177	46.3	1177	6	6	7000	3500	7000	3430	11067	5020
	T/TSF400	157.7	4005	78.5	1993	32.0	813	50.3	1277	50.3	1277	6	6	7000	3500	7000	3350	11067	5020
	TF/TS430	169.5	4305	82.4	2093	35.9	913	54.2	1377	54.2	1377	6	6	7000	3450	7000	3300	11067	5020
	TF/TS450	177.4	4505	86.3	2193	39.9	1013	58.1	1477	58.1	1477	6	6	7000	3400	7000	3250	11067	5020
	TF/TS470	185.2	4705	88.3	2243	41.9	1063	60.1	1527	60.1	1527	6	6	7000	3350	6760	3200	11067	5020
	TF/TS500	197.0	5005	92.2	2343	45.8	1163	64.1	1627	64.1	1627	6	6	5840	2650	5500	2500	11067	5020
	TF/TS550	216.7	5505	100.1	2543	53.7	1363	71.9	1827	71.9	1827	6	6	5250	2380	4950	2250	11067	5020
	TF/TS600	236.4	6005	108.0	2743	61.5	1563	79.8	2027	79.8	2027	6	6	3750	1700	3400	1550	11067	5020
	TF/TS650	256.1	6505	115.9	2943	69.4	1763	86.7	2201	81.1	2061	3	3	3500	1590	3200	1450	11067	5020
4-STAGE FULL FREE LIFT	TF/TS700	275.8	7005	123.7	3143	77.3	1963	94.5	2401	89.0	2261	3	3	2950	1350	2750	1250	11067	5020
	QF610	240.7	6115	84.5	2147	38.1	967	59.6	1514	59.6	1514	3	3	4200	1920	3950	1800	11067	5020
	QF660	260.4	6615	92.4	2347	45.9	1167	67.5	1714	67.5	1714	3	3	3800	1720	3500	1600	11067	5020
	QF700	276.2	7015	96.3	2447	49.9	1267	71.4	1814	71.4	1814	3	3	3100	1410	2850	1300	11067	5020
	QF745	293.9	7465	102.2	2597	55.8	1417	77.3	1964	75.5	1917	3	3	2420	1100	2200	1000	11067	5020
QF790	311.6	7915	108.1	2747	61.7	1567	81.5	2070	75.5	1917	3	3	1750	800	1550	700	11067	5020	

※ TF-Mast : Wide Visible 3-Stage Full Free Lift Mast with 1 Free Lift Cylinder
 ※ TS-Mast : Wide Visible 3-Stage Full Free Lift Mast with 2 Free Lift Cylinders

※ : Standard

New 9 Series

25/30/32/35B-9U

Load Capacity

25B-9U

30B-9U

32B-9U

35B-9U

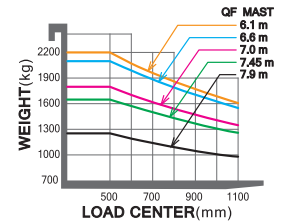
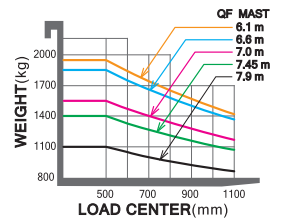
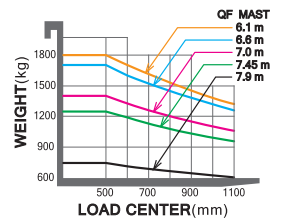
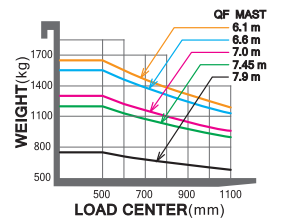
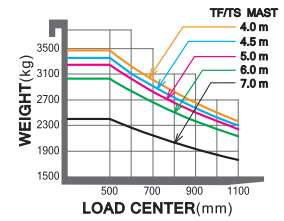
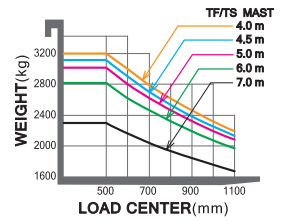
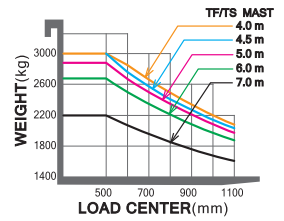
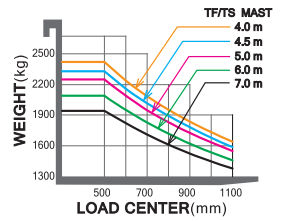
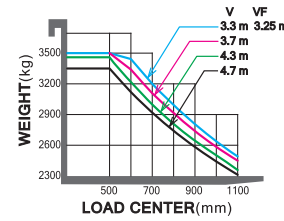
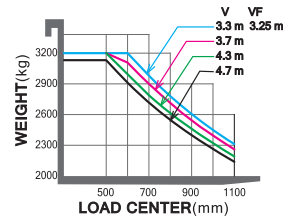
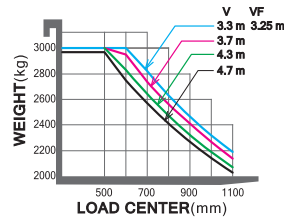
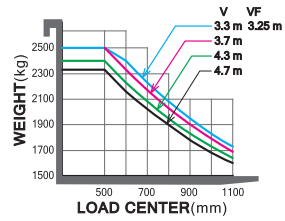

Optional Items

- Fork(mm)
25B-9U : 900, 1000, 1050(STD), 1200, 1350, 1500, 1650, 1800, 2100
30/32/35B-9U : 900, 1050(STD), 1150, 1200, 1350, 1500, 1650, 1800, 1970, 2120, 2300, 2400
- Integral side shift
- Tire :
Solid(STD)/pneumatic/non-marking

- Wide [25/30/32B-9U:Front(23X10-12)]
- Finger Tip Control
- Cold Strage : Applicable to working conditions of up to -30°C
- M.C.V : 2-Spool, 3-Spool(STD), 4-Spool
- Auto fork leveling
- Detachable / attachable battery side items

- Cabin (one-door)
 - ① FRONT + ROOF + REAR
 - ② FRONT + ROOF + REAR + DOOR
 - ③ FRONT + ROOF + REAR + DOOR + HEATER

Various Attachments

Side Shift

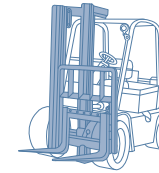

Hinged Fork

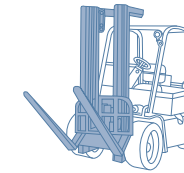

Hinged Bucket

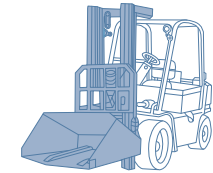

Rotating Fork

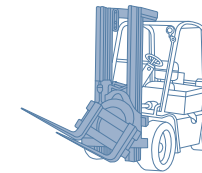

Push Pull

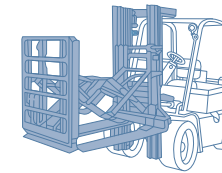

Rotating Roll Clamp

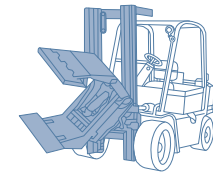

Load Stabilizer

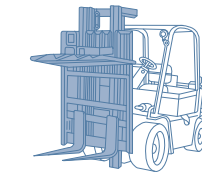

Carton Clamp

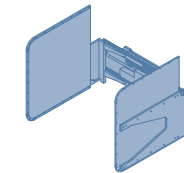

Pallet Invert

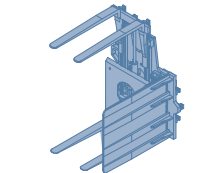

Drum Clamp

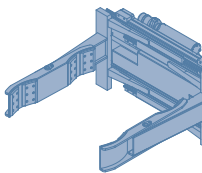

Bale Clamp

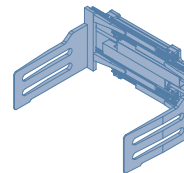

Load Extender

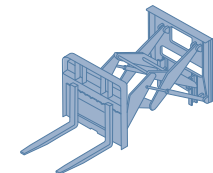

Fork Positioner

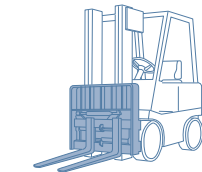

* Exterior designs and forklift options in this catalog may change for improvement

New 9 Series

25/30/32/35B-9U

Specification

DISTINGUISHING MARK		HYUNDAI				
1.1	Manufacturer (Abbreviation)	HYUNDAI				
1.2	Manufacturer's Type Designation	25B-9U	30B-9U	32B-9U	35B-9U	
1.3	Drive: Electric (Battery Or Mains), Diesel, Petrol, Fuel Gas	Electric	Electric	Electric	Electric	
1.4	Type Of Operation: Hand, Pedestrian, Standing, Seated, Order-Picker	seated	seated	seated	seated	
1.5	Load Capacity / Rated Load	kg	2,500	3,000	3,200	3,500
1.6	Load Center Distance	c mm	500	500	500	500
1.8	Load Distance, Center Of Drive Axle To Fork	x mm	458	458	458	470
1.9	Wheelbase	y mm	1,400	1,600	1,600	1,600
WEIGHT						
2.1	Service Weight	kg	4,360	4,633	4,820	5,020
2.2	Axle Loading, Loaded Front / Rear	kg	6,016 / 844	6,812 / 820	7,095 / 925	7,537 / 983
2.3	Axle Loading, Unloaded Front / Rear	kg	1,805 / 2,555	2,016 / 2,617	1,980 / 2,840	1,915 / 3,105
TIRES, CHASSIS						
3.1	Tires: Solid Rubber, Superelastic, Pneumatic, Polyurethane		SE, P	SE, P	SE, P	SE, P
3.2	Tire Size, Front		23X9-10	23X9-10	23X9-10	23X10-12
3.3	Tire Size, Rear		18X7-8	18X7-8	18X7-8	18X7-8
3.5	Wheels, Number Front / Rear (X = Driven Wheels)		2x/2	2x/2	2x/2	2x/2
3.6	Tread, Front	mm	993	993	993	1005
3.7	Tread, Rear	mm	980	980	980	980
DIMENSIONS						
4.1	Tilt Of Mast/Fork Carriage Forward/Backward	degrees	6 / 10	6 / 10	6 / 10	6 / 10
4.2	Height, Mast Lowered	h1 (mm)	2,162	2,162	2,232	2,243
4.3	Free Lift	h2 (mm)	115	115	115	115
4.4	Lift Height	h3 (mm)	3,300	3,300	3,300	3,300
4.5	Height, Mast Extended	h4 (mm)	4,485	4,485	4,485	4,485
4.7	Height Of Overhead Guard (Cabin)	h5 (mm)	2,230	2,230	2,230	2,230
4.8	Seat Height / Stand Height Rel. To Sip	h7 (mm)	1,180	1,180	1,180	1,180
4.12	Coupling Height	h10 (mm)	325	325	325	325
4.19	Overall Length	l1 (mm)	3,345	3,535	3,553	3,640
4.20	Length To Face Of Forks	l2 (mm)	2,295	2,485	2,503	2,590
4.21	Overall Width	b1 (mm)	1,200	1,200	1,200	1,250
4.22	Fork Dimensions	l x e x s (mm)	1,050 x 100 x 45	1,050 x 122 x 45	1,050 x 122 x 45	1,050 x 122 x 45
4.23	Fork Carriage Iso 2328, Class / Type A, B		II/A	III/A	III/A	III/A
4.24	Fork-Carriage Width	b3 (mm)	1,102	1,102	1,102	1,102
4.31	Ground Clearance, Below Mast, Loaded	m1 (mm)	117	117	117	128
4.32	Ground Clearance, Center Of Wheelbase	m2 (mm)	130	130	130	130
4.33	Aisle Width For Pallets 1000 x 1200 Crossways (L x W)	Ast (mm)	3,637	3,829	3,843	3,896
4.34	Aisle Width Of Pallets 800 x 1200 Crossways (W L)	Ast (mm)	3,803	4,009	4,023	4,076
4.35	Turning Radius	Wa (mm)	1,940	2,150	2,165	2,205

PERFORMANCE DATA						
5.1	Travel Speed, Loaded / Unloaded	km/h	17 / 18	17 / 18	17 / 18	17 / 18
5.2	Lift Speed, Loaded / Unloaded	mm/s	420 / 600	340 / 500	330 / 500	300 / 460
5.3	Lowering Speed, Loaded / Unloaded	mm/s	500 / 450	500 / 450	500 / 450	500 / 450
5.6	Max. Drawbar Pull, Loaded / Unloaded	N	14,710/14,690	14,640/14,700	14,580/14,660	14,580/14,410
5.8	Max. Gradeability, Loaded	%(*)	22 (12.4)	19 (10.8)	18 (10.2)	17 (9.6)
5.10	Service Brake		Hydraulic	Hydraulic	Hydraulic	Hydraulic
ELECTRIC-MOTOR						
6.1	Drive Motor Rating S2 60 Min	kw	7.0x2	7.0x2	7.0x2	7.0x2
6.2	Lift Motor Rating At S3 15%	kw	17	17	17	17
6.4	Battery Voltage, Nominal Capacity K5	V/Ah	48 / 660	48 / 715	48 / 715	48 / 715
6.5	Battery Weight (Min.)	kg	1,090	1,150	1,150	1,150
	Battery Compartment Dimensions L/W/H	mm	1,035 / 800 / 540	1,035 / 1,000 / 540	1,035 / 1,000 / 540	1,035 / 1,000 / 540
ADDITION DATA						
8.1	Type Of Drive Control		AC	AC	AC	AC

Dimension

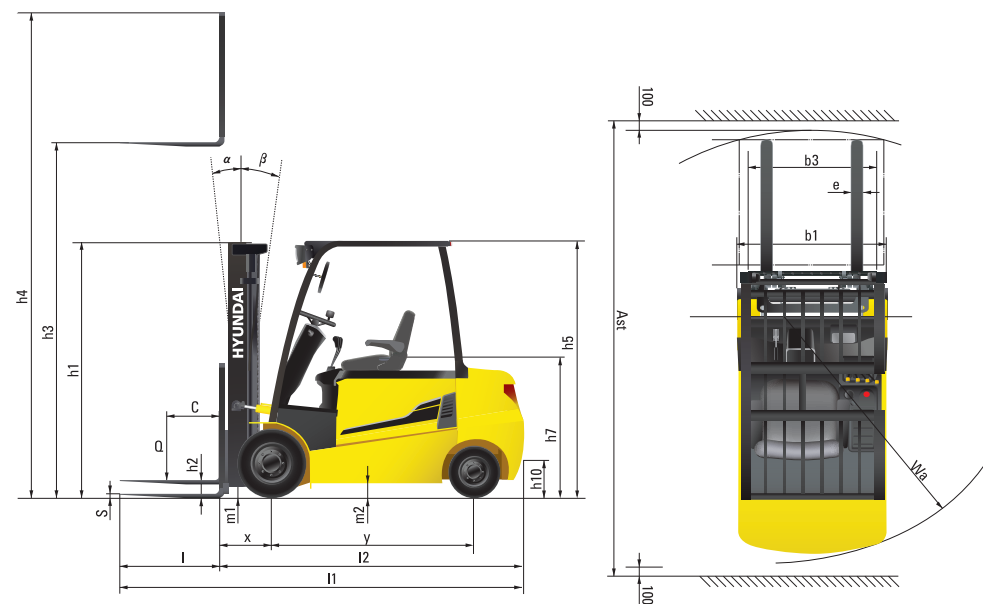

* Exterior designs and forklift options in this catalog may change for improvement

Forklifts of Michigan
www.forkliftsmi.com
616-455-2376



www.hyundai-mh.com / 2019. 07 Rev. 6