

Reliability.

It's the defining trait of our company and our forklifts.



UniCarriers' roots extend back over 100 years, and over that time, strong, reliable performance has always been the hallmark of our organization, our people and our equipment.

Today, our unrivaled reliability continues to provide UniCarriers' customers with a competitive edge. And together, we move the merchandise that moves world commerce with greater efficiency, economy and reliability.

When it comes to providing forklifts that make a difference for our customers and theirs...

We Never Quit.



SB-SRX 07-2015 Printed in U.S.A.

UniCarriers® is a registered trademark of UniCarriers Corporation. UniCarriers Americas Corporation reserves the right to make product changes relating to colors, equipment, specifications or available options without notice. For more information, contact your UniCarriers representative.



UNICARRIERS®

□ FORKLIFT □



Single & Double Reach Trucks

36 Volt AC-Powered

3,500 & 4,500 lbs. Capacities | Single Reach

3,000 lbs. Capacity | Double Reach

SRX Series

SRX Series Applications

Extraordinary maneuverability, electronic steering and adjustable performance settings combine to make UniCarriers SRX Series Single and Double Reach Trucks the right choice for any operation where space is at a premium, including:

- Refrigerated Warehouses
- Grocery Distribution Centers
- Home Improvement Centers
- Retail Department Stores
- Manufacturing



Look for this symbol — it identifies a UniCarriers forklift feature that provides a proven performance advantage as compared to competitive trucks.



NEVER QUIT.

It defines our forklifts and the company that builds them.

Over the course of a century, the company known as UniCarriers took shape. As we grew and evolved into a US manufacturer with a global reach in nearly 100 countries worldwide, much has changed, but one thing hasn't: our mission. UniCarriers is committed to providing you with the ultimate in reliability, performance, and value.

And that commitment can be seen in the SRX Series. These powerful, versatile trucks are designed for navigating narrow aisles...expanding available space... and quickly moving, staging and storing heavy loads. And they do it all with the maximum efficiency, operating ease, and operator comfort that define the SRX Series. With its rugged, proven design, SRX Series trucks deliver greater uptime and are both easy to operate and, with standard on-board diagnostics, just as easy to service.



Up Your UpTime

Discover reliability features that cut downtime and keep your business up and running



Comfort Zone

Your drivers and your entire operation will benefit from our comfort & productivity features



Power & Performance

AC motors and controllers are only the beginning of our performance advantages



Sweet Savings

The SRX is designed to deliver you a low cost of ownership year after year after year



Play It Safe

Safety is everybody's business, and the SRX is all business when it comes to safety



Control Freak

With the SRX, you're in complete control when it comes to managing costs and productivity



Make It Yours

Already well appointed, the SRX can be customized to meet your specific needs



To learn more, and a find a dealer near you, visit UniCarriersAmericas.com



Up Your UpTime

Reliability is the key to bringing your operation greater productivity and profits. That's why the SRX is engineered and built to deliver maximum uptime – all the time. From its simple design to its high performance components, you'll find the SRX is engineered to reliably move your business forward.



Fewer Parts Mean Greater Reliability

The SRX Series features an **AC drive and hydraulic motor and controller system** that features fewer serviceable parts and delivers ultra-reliable performance while keeping operating cost low.



Stay Cool



At higher operating temperatures, **built-in thermal sensors** alert the operator and automatically reduce performance to protect the drive motors, pump motor and controller system.

Simple Efficiency



The use of Hall Effect sensors and magnetic reed switches in the control handle — as well as encoders used in the motors and steering tiller — mean **no heating components are needed for cold or freezer operations**. This design also minimizes the effect of debris on the truck's operation, resulting in **more uptime and greater productivity**.



Get Back Up Again Quickly



Our sophisticated CAN-Bus Network continuously monitors the truck's key operating systems, providing **smooth operation and continuous diagnostics** of all truck components.

The LED meter panel is the portal to your truck's performance, providing **ready access to system status, fault codes, service history, and driver alerts** to minimize maintenance and downtime. Unlike competitive models, no tablet, laptop, or handset tool is needed to access this information.



Cutting Costs without Cutting Corners

To deliver greater uptime, the SRX incorporates a wealth of reliability promoting features, including its **stationary drive and steer motors that eliminate cable flexing** and as a result, possible wiring damage. Other long-life components include a heavy-duty, DC steering motor.





Comfort Zone

When productivity counts, operator comfort is not a luxury. That's why the SRX features a roomy compartment designed to improve the performance of your operators. From smooth, precise controls and an adjustable backrest to minimal vibration, your operators will always be comfortably in control of their reach truck – and any situation that might arise.



Plush Surroundings

The operator compartment features a padded armrest, a 57-1/2" backrest that adjusts up to 6" for a customized fit, plus a thick floor mat and kneepad.



Smooth Operator

Unlike most competitive forklifts, the platform of the SRX is not bolted to the frame, but sits on **four vibration isolators to absorb shock**.



- Vibration Isolators
- Cushioned Floor Mat
- Sloping Floorboard

57-1/2" adjustable backrest



Ergo Design

Shaped with an **angled grip for comfortable all-day operation**, our joystick is ergonomically designed for comfort and ease of use – even with freezer gloves. The low-effort, sealed switches also help reduce operator fatigue.



Cushioned Reach Retraction

To reduce shocks to the operator and equipment, the SRX has a hydraulically cushioned retract function. The results: **smoother operation**, more secure handling of loads, and **less operator fatigue**.



Electronic Steering

Electronic controlled steering makes it **easy for operators to navigate tight quarters**. Steering mode (forward or reverse) can be changed by a trained service technician using the meter panel.



Low Profile Pedals

Low profile pedals offer **greater operator comfort** and control. A divider separates the two pedals to discourage operators from depressing both pedals with one foot, helping to keep the other foot securely within the compartment while driving.



Driver Friendly Environment

Designed for the operator to lean back comfortably, the **floor is slightly angled for optimum foot positioning**. Side stance operation promotes maximum driver comfort while traveling in forward or reverse.

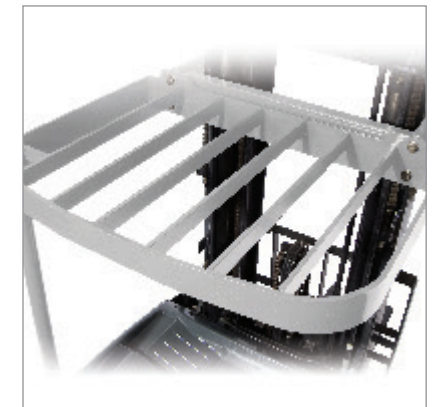

Perfect Vision

The overhead guard is designed with **wide canopy channels** to produce clearer visibility at higher lift heights.



Power & Performance

When it comes to high performance in narrow aisle applications, the SRX delivers. Beyond fast travel, lift and reach/retract speeds, the SRX features durable construction that allows your operators to master any task, moving loads quickly with greater precision. The SRX is designed to get your business moving, and keep it moving in the right direction.



Superior Performance Up and Down Your Aisles

Specifically designed for the SRX, the AC motors are matched with a controller that's tuned to their precise torque and power curves. The result is **quick acceleration**, higher productivity, **low energy consumption**, and fast operating speeds.

Travel Speeds

6.4/7.2
MPH

Full load/No load

Lift Speeds

70/120
FPM

Full load/No Load



Our High-Visibility, Rigid Mast Gives You More Flexibility

Achieve greater productivity with the SRX Series' high-visibility mast. Its rugged construction features **two interlocking I beam rails** nested within a rigid outer channel, and includes **six heavy-duty rollers** from carriage to mast rail.

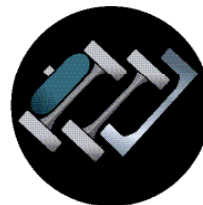

Wide Drive Wheel

The wide drive wheel delivers greater **durability and longer life**, as well as smoother operation over floor joints.



Greater Strength with Simpler Maintenance

The SRX reach mechanism incorporates canted roller bearings that travel within the bounds of the mast's "I" beam inner rails. As the mast extends, these angled bearings remain fully nested inside the mast channel. As a result, the **entire carriage assembly is extremely rigid** within the tapered mast railing design, producing **superior capacity retention** at higher lift heights.

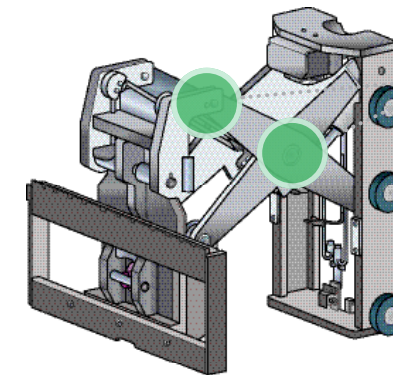

Several grease points are easily accessible, promoting good maintenance habits.

Double Duty

The SRX pantograph incorporates **dual reach cylinders to reduce stress and distortion**, while evenly distributing the load for reduced shock and wear. Its rugged double carriage design provides a full 40" stroke (shown), and 20" for single reach.

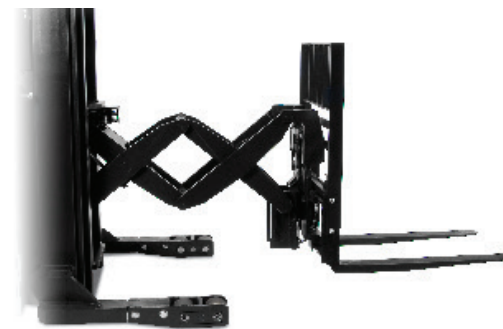

Easy Handling

On-demand power steering with low-input torque, a **small steer tiller wheel and tiller knob**, combine to provide exceptional operator control with minimum effort.



Durability from the Ground Up

The SRX outriggers are **welded to the mast rails for superior structural strength, stability and support**. Choose from a variety of available load wheel and outrigger tip designs based on the racking configuration and products handled in your operation.





Sweet Savings

Saving you time, effort and expense is at the heart of the SRX Series. From systems that conserve energy to designs that reduce wear, the SRX delivers more uptime, while lowering your costs. With features like on-demand hydraulics and power steering, regenerative braking, and self-diagnostics, the SRX can lift heavy loads and your bottom line profitability.

IP65 Rated Sealed Controller locks out dirt and debris that can harm performance and contaminate internal components.

Stationary drive and steer motor eliminates cable flexing and possible damage.



Standard thermal protection on all AC motors and controllers warn against possible overheating.

Wide drive wheel delivers greater durability and longer life.

Dual, articulating caster wheels **minimize tire scrubbing and wear** when pivoting.



Extended major service intervals of 1,200 and 2,400 hours mean more uptime with less time and expense required for maintenance.

Low maintenance brake only needs inspection every 12 months or 2,400 hours.

Includes standard battery rollers and gates. Battery gate warning feature is optional.

Non-contact switches and sealed sensors in the control handle **require no adjustments**, lowering maintenance costs.



More Power to You

The SRX offers advanced regenerative technology to reclaim power from four different operations — lowering power consumption, **extending operating hours, reducing component wear**, and keeping your equipment out of the charging bay.

Power Savers

To reduce power consumption and keep your truck moving longer, the SRX Series features:

On-demand hydraulics — if no command is given, the hydraulic motor turns off.

On-demand electric power steering — the steering is triggered only by tiller movement.

Auto-power off — cuts the electrical system if the forklift sits idle. Select an allowable idle time between 15 and 60 minutes before the vehicle powers down.

Advanced On-Board Diagnostics

The SRX features on-board self-diagnostics that **protect the motor and controller** by continuously monitoring for errors, faults, and high temperatures. It also provides **access to the truck's service history** and is available through the meter panel for quick troubleshooting. No tablet, laptop, or handset tool is required.

Together, these features increase productivity and uptime, while keeping services expenses down.

Quick Access

Service points are easily accessible through removable top and front panels for speed and ease of maintenance.

- 1 Plugging
- 2 Operator Presence
- 3 Neutral Brake
- 4 Brake Pedal

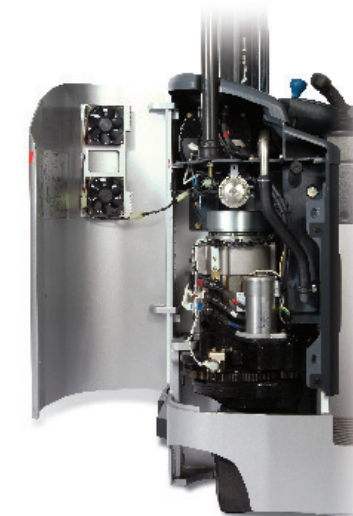



Play It Safe

Safety is everybody's business and the SRX is designed to help you bring greater security to your operators, your inventory, and your facilities. Through innovative technology and essential systems, the SRX gives your operators maximum control and confidence as they navigate narrow aisles and help steer your business in the right direction.

Surrounding Your Operator with Greater Security

To help safeguard your operator, the SRX includes a host of advanced features:

- **Return-To-Neutral** — system is engaged if presence or brake pedals are released, and before resuming travel; prevents unintended movement at start up
- **Lift Control** — restricts lift speeds at faster travel speeds
- **High Mast Travel Speed Control** — restricts the maximum speed when the mast is above free-lift
- **Power Disconnect Switch** — shuts off battery power (to be used only in emergencies)



SRX offers advanced anti-rollback protection, ideal for minimizing push-back when placing loads. (See page 15 for details.)

Operator Presence System

To keep your operator and other staff secure, the SRX features an **auto-mast lock** that disables the hydraulic function if the presence pedal is not depressed. Plus, if the brake pedal is released, **the vehicle will quickly slow down and stop** — an essential feature in the event of an emergency.



Digital Fork Height Indicator

Using this optional system, the fork height is displayed on the meter panel, giving operators a confidence boost while working areas with high racking.



Automatic Fork Height Selector

This optional feature helps operators move loads with greater efficiency. Invaluable during storage and retrieval operations, the selector offers **six different rack height settings**, with loaded (or unloaded) fork height stops. The Digital Fork Height Indicator is included.



Visibility of a Higher Degree

The SRX Series 90° side stance was determined by overwhelming operator preference. As taller loads have become more common, operators frequently travel in reverse for better visibility. Side stance offers operators a simple way to **adjust their view without having to reposition their bodies**, thus maintaining critical control of all operating functions.



Auto Park Prevents Unintended Vehicle Movement

There's no need to set a separate brake with the SRX. The parking brake is automatically applied when the truck comes to a complete stop.

The pedals also feature a **divider that separates the pedals**, assuring that both feet must be in the compartment and the operator is in a safe operating position.



Control Freak



The command and control features of the SRX give your operators complete control over their vehicle, the loads they transport, and the environment they work in. The SRX also provides you with greater control to manage your operation and costs. Increased productivity, performance and profitability are what drive the SRX.

Superior Control in Sight and at Hand

The large, bright, backlit LED meter panel provides your operators and technicians with all the information they need to operate and maintain the SRX with greater ease and precision.

Operating Information

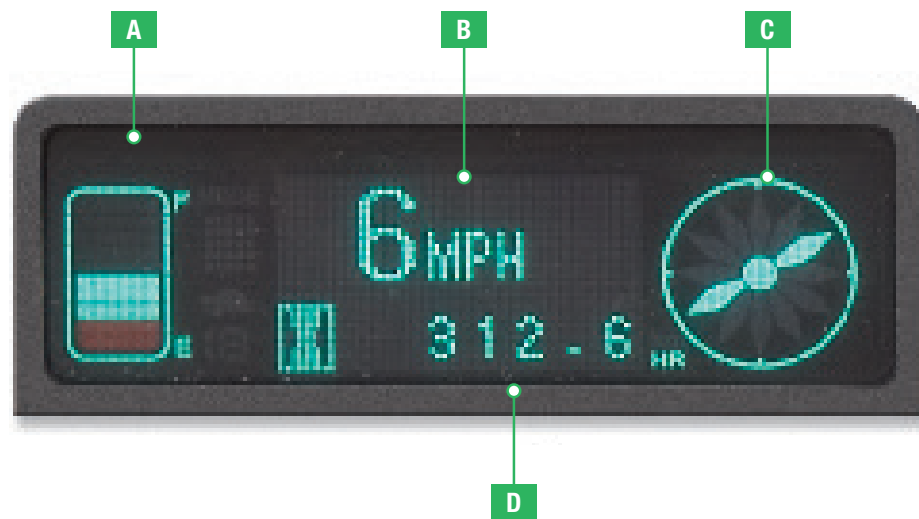

- A** Battery Discharge
- B** Travel Speed (Parking Brake Warning)
- C** Steer Wheel Position
- D** Key-On (Total) Hours

Speed Sensing Steer Control

With this standard feature, operators experience a quicker response to their steering commands while the SRX is traveling at a faster rate. This control also allows operators to perform operations using slower, more precise movements when driving at a slower speed, such as negotiating aisles or racking.



Hour Meter Readings

The display provides 4-mode hour meter readings, including total operating time, drive motor, lift motor, and operator presence pedal.



Performance Settings

Performance settings, such as maximum travel speed while the mast is raised (shown), reach extension speed, and regenerative braking, can be adjusted by a trained service technician.



On-Board Self-Diagnostics

The self-diagnosis display includes flashing icons and alphanumeric codes to warn the operator when errors are detected in the truck's operating system. A technician can also review service history, as well as activate and change service settings without the need for a laptop, tablet or handset tool.



Greater Control Right at Your Fingertips

The SRX features our exclusive, ergonomically designed multi-function control handle. Highly intuitive, the handle offers simultaneous control of drive, lift-and-lower, reach-and-retract, horn, and auxiliary functions — all while reducing operator stress and fatigue.

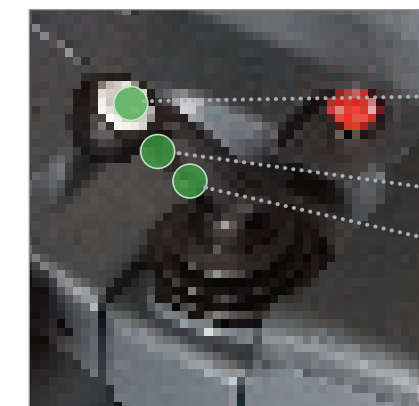

- Sideshift & Carriage Tilt
- Horn (back)
- Reach Extension
- Reach Retract

Anti-Roll Back Protection

If the travel control is returned to neutral while traveling on a ramp, the controller will reduce and stop movement down the slope. When coming to a stop on a ramp, the SRX controller will apply motor torque to maintain position on the slope, until the automatic parking brake applies.





Make It Yours

Since each narrow aisle application is unique, the SRX can be customized in a variety of ways, including lift heights, outrigger design, fork lengths, load wheel options, side shifter, and even load wheel box tips. You can also choose from a wide array of performance enhancing options to tailor the SRX to your specific requirements. If you don't see what you need, contact your authorized UniCarriers dealer for more options.



Digital Fork Height Indicator

Fork height is displayed on the meter panel, giving operators confidence while working in areas with high racking.



Automatic Fork Height Selector

Save valuable time during storage and retrieval with six different rack height stop settings.



UL "EE" Rating

Available on 16.4" battery compartment models, includes enclosed motors, cover over main contactor and key locked battery compartment doors.

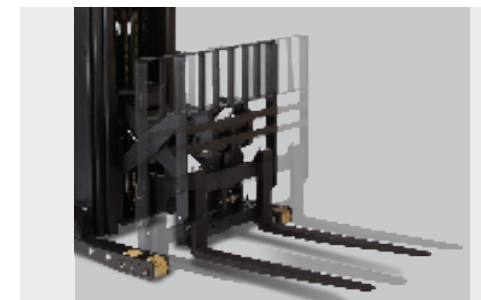

Integral Sideshifter

Operators will experience greater efficiency due to fewer required moves when storing or retrieving loads.



Travel Alarms

Ideal for increased awareness. Provides additional security in busy operations.

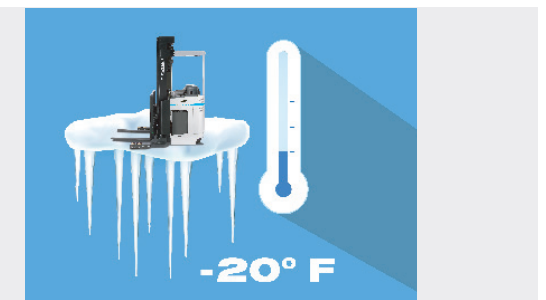

Freezer Package

For operating environments as low as -20° F (-29° C) — includes special hydraulic oil.



Lighting Package

Fan and compartment light are mounted on the overhead guard canopy for greater comfort and convenience.

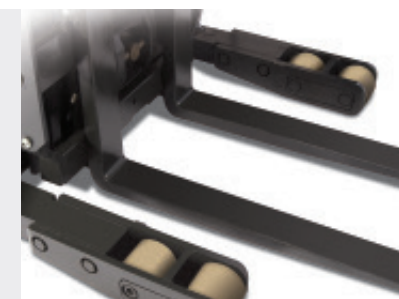

Variety of Outrigger Tips

Select from box end (shown) or tapered tips for easier access and less load jarring during straddle-type entry — a popular choice for double reach trucks.



LED Work Lights

Overhead guard-mounted front or rear LED work lights offer greater visibility. Strobes bring added security to your operation.

Option Availability

● Standard ○ Optional

VEHICLE MANAGEMENT	
AC motor controller with built-in self-diagnostics	●
Multi-function LED display	●
Battery discharge indicator with lift interrupt	●
Four individual hour meter readings	●
Multi-function control handle	●
Emergency power disconnect switch	●
Motor and controller temperature protection	●
Digital fork height indicator	○
Automatic fork height selector (includes digital fork height indicator)	○
CHASSIS & MAST	
AC drive motor	●
36-volt electrical system	●
Battery compartment rollers and side gates	●
Three stage mast: 95" OHL / 210" MFH	●
48" high load backrest	●
U.L. "EE" rating (with 16.4" battery box only)	○
Freezer Package (32°F/0°C to -20°F/-29°C)	○
OUTRIGGERS	
33" - 50" I.D. base legs	●
5" x 4" tandem load wheels	●
10.5" x 4" single load wheels	○
5" x 3" tandem narrow load wheels	○
4" x 3" tandem low profile load wheels	○
Tapered outrigger tips (load wheel guard)	○
OPERATOR PRESENCE SYSTEM	
Operator presence pedal with mast lockout and return-to-neutral	●
Brake pedal (depress to travel)	●
STEERING SYSTEM	
On-demand electronic power steering	●
Small radius tiller and speed sensor steer control	●
Steer tire position indicator	●
Reverse steering	○
BRAKE	
Automatic parking brake with anti-rollback and ramp start	●
4-mode regenerative braking	●
HYDRAULIC SYSTEM	
AC hydraulic pump motor	●
Proportional lift and lower	●
Integral sideshifter	○
OPERATOR CONVENIENCES	
90° operator side stance	●
Anti-fatigue arm, knees, and back padding	●
Adjustable operator back rest cushion	●
Safety glass mast guard	●
Wire mesh mast guard	○
Operator fan and light	○
Front or rear LED work lights	○
Travel alarm	○
Strobe lights	○

Specifications

MODEL	SRX35N Single Reach	SRX45N Single Reach	SRX30ND Double Reach
Capacity ¹ - lb (kg)	3500 (1750)	4500 (2250)	3000 (1500)
Voltage	36	36	36
Base Leg Opening - Inner Dimension - in (mm)	33 to 50 (840-1270)	33 to 50 (840-1270)	33 to 50 (840-1270)
Battery Compartment Length - in (mm)	16.4 (415)	16.4 or 20.9 (415 or 530)	16.4 or 20.9 (415 or 530)
Maximum Fork Height ² - in (mm)	210 (5335)	210 (5335)	210 (5335)
Max Travel Speed: Full Load/No Load - mph (kmh)	6.4/7.2 (10.3/11.6)	6.4/7.2 (10.3/11.6)	6.4/7.2 (10.3/11.6)
Max Lift Speed: Full Load/No Load - fpm (mm/s)	70/120 (355/610)	70/120 (355/610)	70/120 (355/610)
Max Lower Speed: Full Load/No Load - fpm (mm/s)	95/87 (485/440)	95/87 (485/440)	95/95 (485/485)

¹ Based on 24" load center.

² Based on Three-Stage mast. Measured to top of forks.